

SERIE - SERIES KAPPA

806700 KAPPA 100 1C
807600 KAPPA 100 TS 2C

806600 KAPPA 100 VA
807700 KAPPA 100 TS VA
807800 KAPPA 100 TS MF

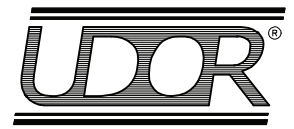

KAPPA 100 1C

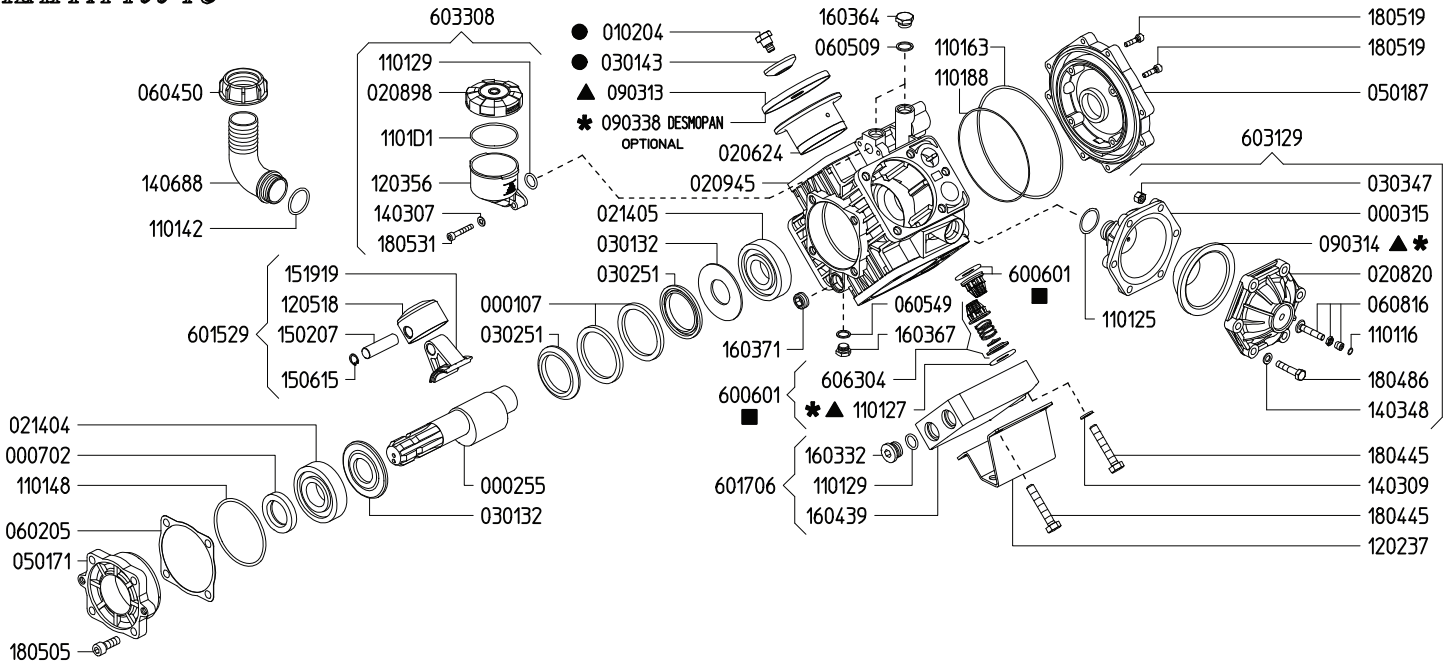

KAPPA 100 TS VA

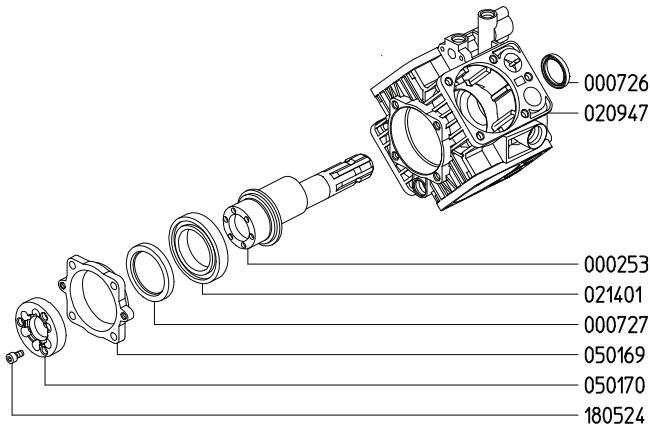

Variante versione TS VA rispetto alla 1C
Variables of version TS VA compared to 1C

KAPPA 100 TS MF

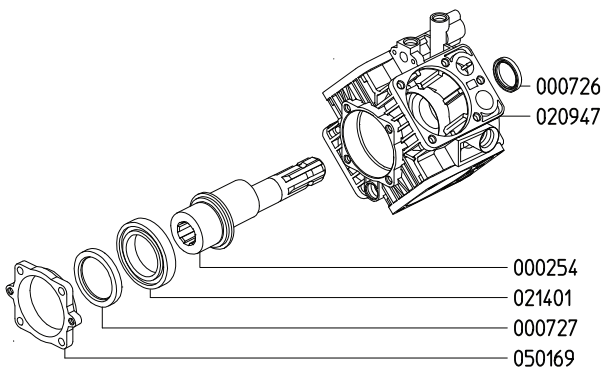

Variante versione TS MF rispetto alla 1C
Variables of version TS MF compared to 1C

KAPPA 100 VA

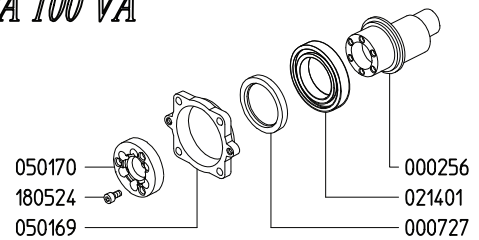

Variante versione VA rispetto alla 1C
Variables of version VA compared to 1C

KAPPA 100 TS 2C

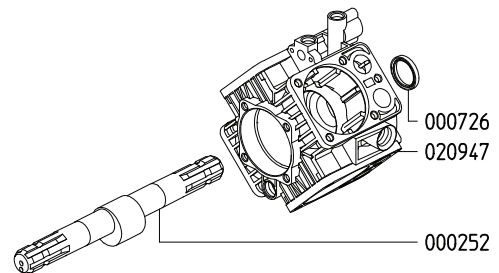

Variante versione TS 2C rispetto alla 1C
Variables of version TS 2C compared to 1C

KIT 632		KIT 508		KIT 509		KIT 511	
870024		606209		606210		606212	
*		▲		■		●	
CODICE CODE	Q.TA' Q.TY	CODICE CODE	Q.TA' Q.TY	CODICE CODE	Q.TA' Q.TY	CODICE CODE	Q.TA' Q.TY
090314	1	090313	4	600601	8	010204	4
090338	4	090314	1			030143	4
110127	8	110127	8				